

P50L PEITTEIDEN LIITTÄMINEN NAPSU JÄRJESTELMÄÄN
P50L MOUNTING PROFILE

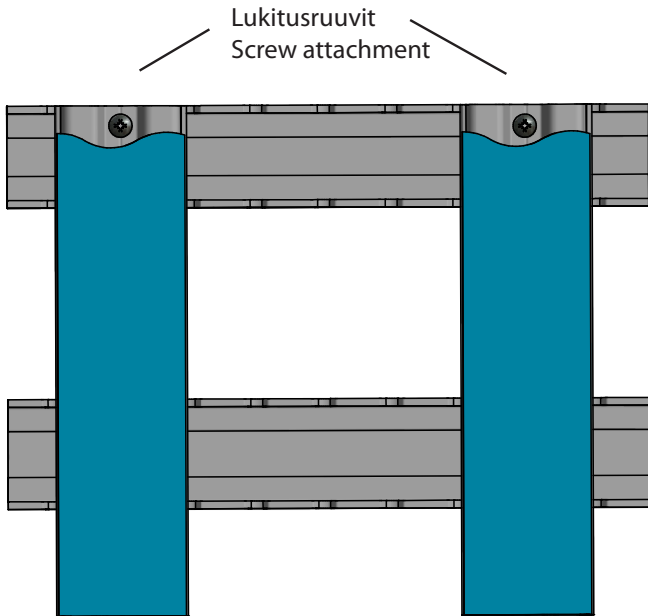

Haluttaessa käyttää P50L sarjan peitteitä käytetään kiinnitysprofilia P-18541
Mounting profile P-18541 is used when P50L cover profiles are used for NAPSU-P50L purpose

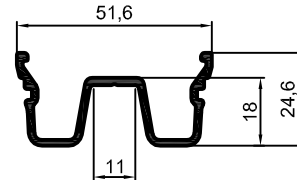

P-18541

Esimerkkejä P50L sarjan peitteistä
Lisää P50L sarjan sivuilta
Peitteen sopivuus tarkistettava

Few samples of P50L cover profiles
More cover profiles can be found from P50L catalogue
Suitability of cover profile has to be ensured from sales

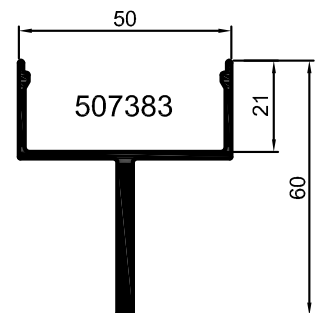
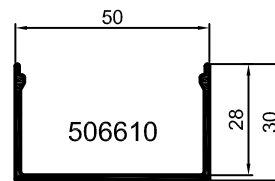
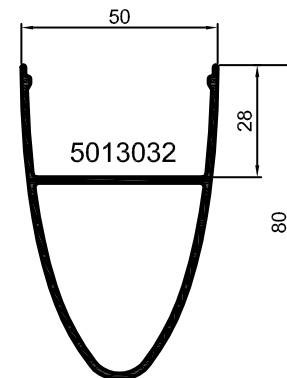
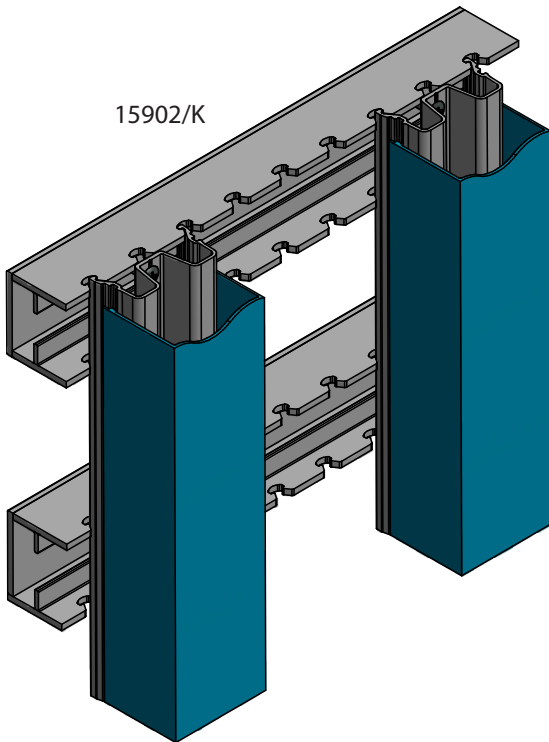

Kiinnitysprofilia P-18541 voidaan käyttää pysty- ja vaakatasossa
Mounting profile P-18541 can be used vertically and horizontal

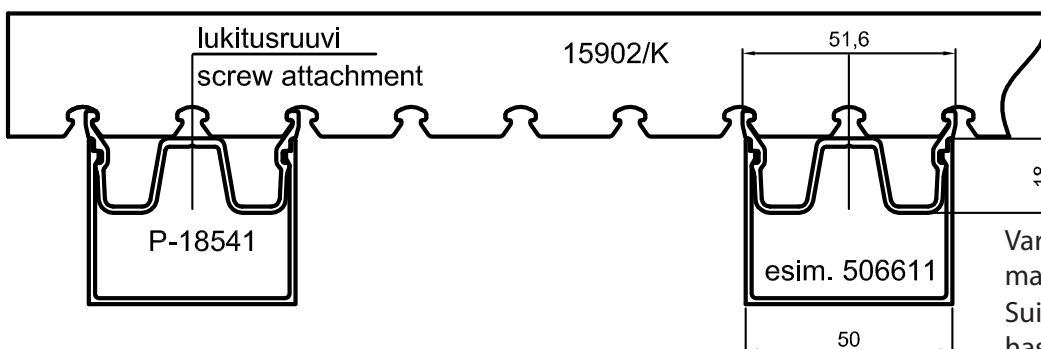

Varmistettava että peite mahtuu paikalleen
Suitability of cover profile has to be ensured from sales